

Article number: 201580M825MT

Description: E+G Screw GN 1580-M8-25-MT-H
Hygienic design

Measures

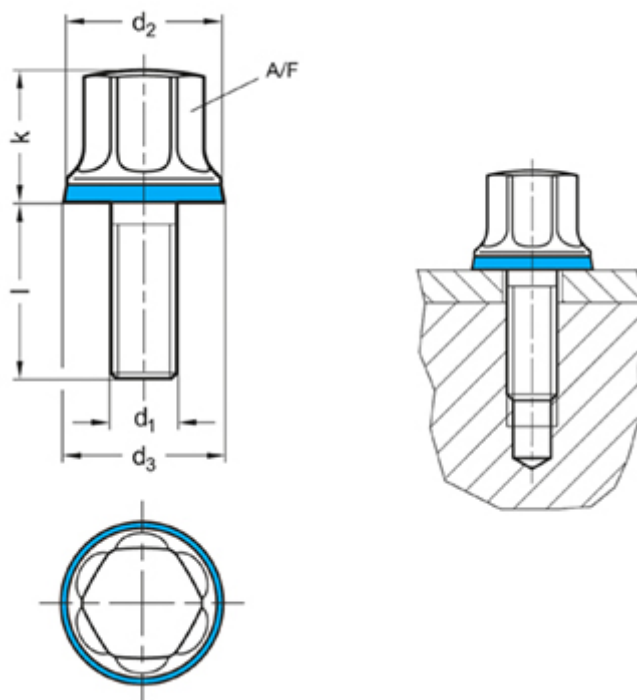

d1	= M 8
d2	= 18
d3	= 18.8
k	= 14.5
L	= 25
t min	= -
Weight in (g)	= 25